



SPICER[®]

MODEL

44

**EXTERNAL
TYPE**

**FRONT AXLE
HUB LOK[®]**

SERVICE MANUAL

AXLE DIVISION

DANA

DANA CORPORATION

SUBMERSION OR DEEP WATER FORDING

If the vehicle is exposed to water deep enough to cover the hubs of either the front or rear axles, it is recommended that the wheel ends be disassembled and inspected for water damage, and/or contamination daily.

Clean, examine and replace damaged parts if necessary, prior to relubricating and assembling the wheel end components. Pay particular attention to the bearings and the closed steering knuckle on the front driving axle.

In the event the gear carrier housing should become submerged in water, particularly if over the breathers, it is recommended that the hypoid gear lubricant be drained daily and internal parts be inspected for water damage and/or contamination.

Clean, examine and replace damaged parts if necessary prior to assembling the cover to housing and refilling with the specified hypoid lubricant.

CLOSED WHEEL END STEERING KNUCKLE LUBRICATION

The closed steering knuckle requires lubrication from a source other than the gear carrier assembly. Inboard tube seals contain the hypoid gear lube in the housing to provide an adequate lubricant level for the gears, bearings, etc. This then requires an additional lubricant level to be maintained outboard, in each steering knuckle, which can be observed by removing fill plugs on each knuckle. Adequate level would be to the bottom of the fill plug hole, when vehicle is observed to be in a normal horizontal position.

Recommended lubricant is an SAE 140 grade, multipurpose gear lubricant meeting the Mil-L-2105B Spec.

HUB/LOK LUBRICATION

The "O" ring is to be lubricated with "Parker "O" Ring Lube".

It is recommended that the internal parts of the Hub/Lok, such as the gear teeth and splines, are to be lubricated with Moly XL hi-speed grease.

OPERATION

Hub/Loks are designed to eliminate unnecessary wear to front drive components. When the Hub/Loks are disengaged, the vehicle is in two-wheel drive (rear wheels only). The front wheels now turn freely on the spindle bearings.

This eliminates the rotating of the axle shafts, ring gear, pinion gear, and front prop shaft, which decreases tire wear and engine load.

CAUTION

Four-wheel drive, with Hub/Loks engaged, should only be used when operating conditions make it necessary. To avoid overloading the rear axle, never operate with transfer case in low range, four-wheel drive position, with Hub/Loks disengaged.

NOTE

Some residual driveline "wrap-up" will normally be present after four-wheel drive operation, and the Hub/Loks will be difficult to disengage unless the transfer case is shifted to two-wheel drive or neutral. Always shift to two-wheel drive or neutral prior to disengaging Hub/Loks. If transfer case is difficult to shift, driving the vehicle a few feet forward or backwards will normally remove some of the driveline wrap-up and ease shifting.

CAUTION

Hub/Loks should always be disengaged with vehicle on level surface and parking brake set to guard against vehicle moving while unattended.



1001-1



1001-2

(Figure 1) To engage Hub/Loks turn knob to lock position as shown.

(Figure 2) With knob in *Lock* position, both the inner clutch gear and outer clutch gear teeth are meshed (engaged) as shown.



1001-3



1001-4

(Figure 3) To disengage Hub/Loks turn knob to *Free* position as shown.

(Figure 4) With knob in *Free* position, both the inner clutch gear and outer clutch gear teeth are now separated (disengaged), as shown.

INSTALLATION

In the event the vehicle was not originally purchased with Hub/Loks, the following steps should be followed to convert from conventional hubs to Hub/Loks.

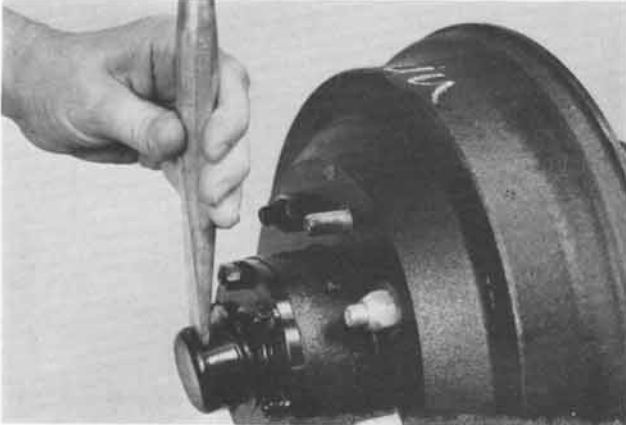

1001-5

(Figure 5) Remove hub cap and discard.

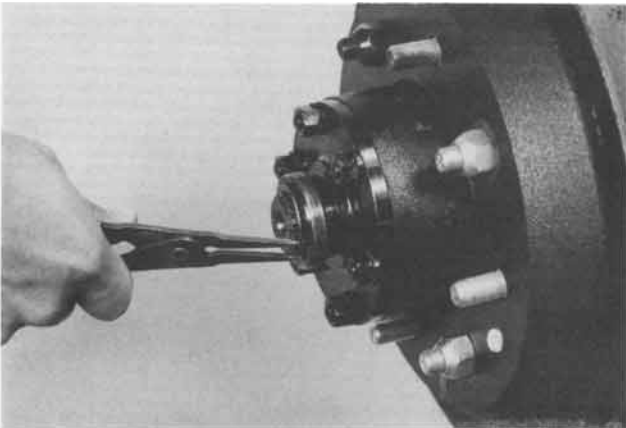

1001-6

(Figure 6) Remove snap ring and discard.

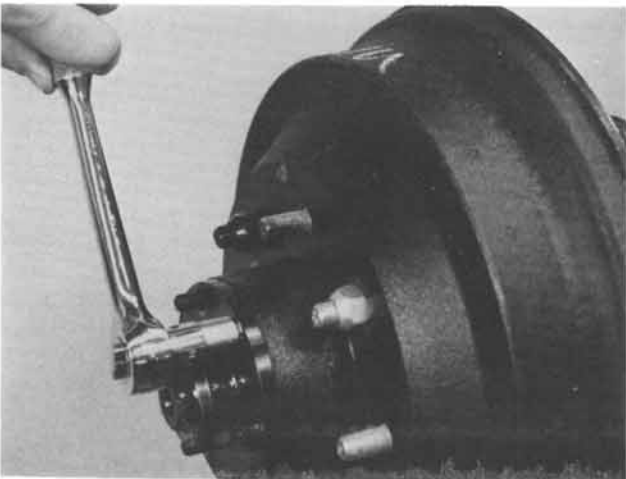

1001-7

(Figure 7) Remove nuts and washers and discard.

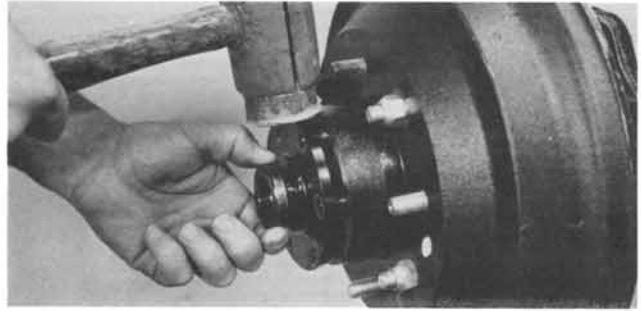

1001-8

(Figure 8) Remove drive flange and gasket and discard. To free flange from hub, tap lightly with a rawhide hammer.

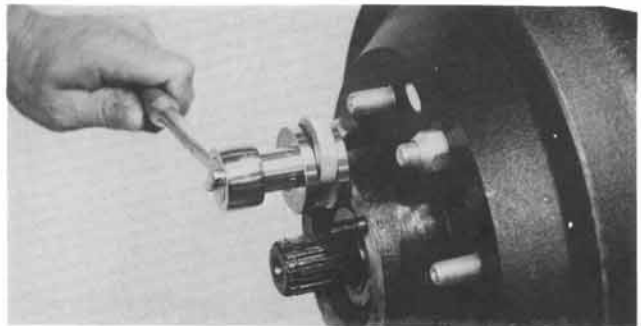

1001-9

(Figure 9) Remove six studs with a stud puller, and discard studs.

NOTE

Before assembling Hub/Loks inspect the splines of the axle shaft making sure they are free of any possible nicks or burrs.

ASSEMBLY OF HUB/LOKS

Apply a small amount of Moly XL hi-speed grease to the backface and the thrust face of the bushing, also to the splines of the inner clutch gear. Assemble inner clutch gear into bushing.

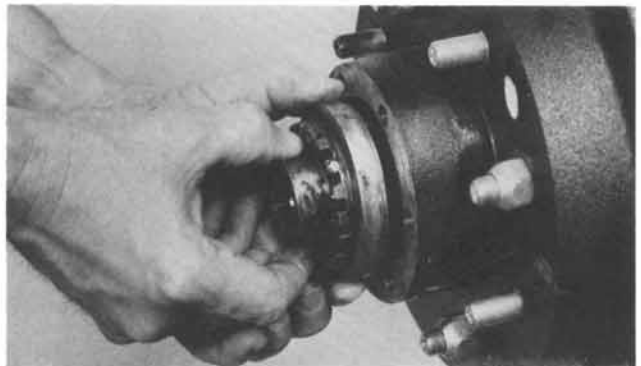

1001-10

(Figure 10) Assemble bushing and inner clutch gear onto axle shaft, making sure the splines of the inner clutch gear are aligned with the splines of the axle shaft, as shown.

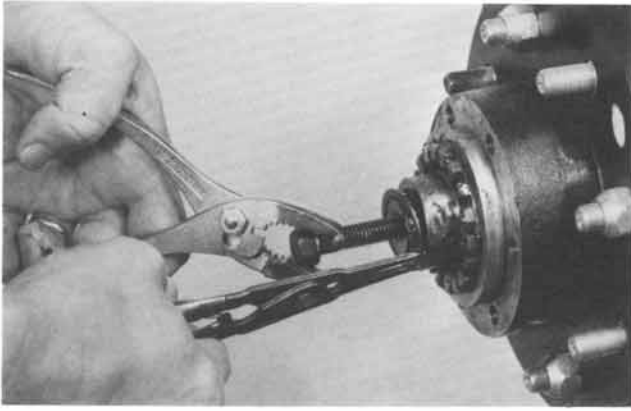

1001-11

(Figure 11) Assemble new snap ring. If necessary, pull out axle shaft with cap screw to allow clearance in groove for snap ring on axle shaft. Be sure snap ring is fully seated.



1001-12

(Figure 12) Apply a small amount of Parker "O" ring lubricant on the actuator knob, making sure knob is completely lubricated in the area shown. Assemble "O" ring onto actuating knob.

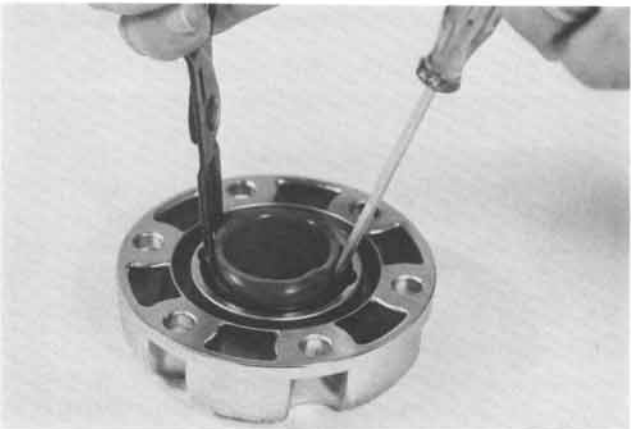

1001-13

(Figure 13) Assemble actuating knob into the knob retainer with arrow pointing to free position. Assemble knob retainer snap ring. Spread snap ring with snap ring pliers. Use a small screw driver to position the snap ring in the groove of the knob.

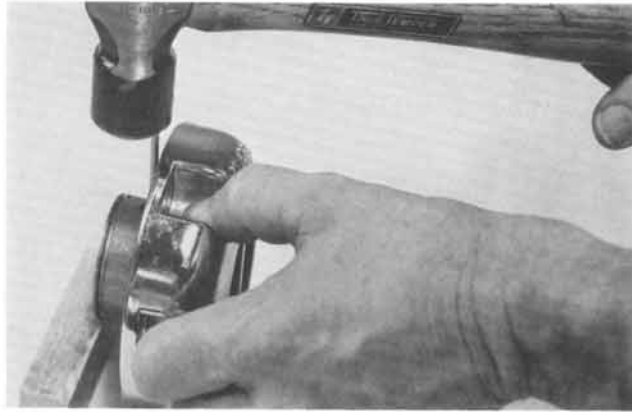

1001-14

(Figure 14) Assemble actuating cam onto the knob, aligning ears of the cam with the ears of the retainer. Position parts on a small piece of wood as shown. Assemble the lock pin through the groove of the cam and holes in the actuating knob. Be sure ends of the pin are flush with the outside diameter of the cam.

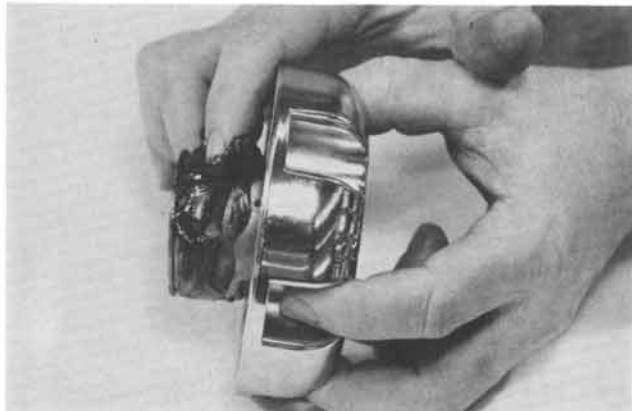

1001-15

(Figure 15) Turn actuator knob to *Lock* position. Apply a small amount of Moly XL hi-speed grease to both grooves of the cam, as shown.



1001-16

(Figure 16) Assemble pressure spring and outer clutch gear. Compress the pressure spring by forcing down on clutch gear and assemble snap ring. Make sure snap ring is secure in the groove of the cam. Turn actuator knob to free position. Assemble six dished washers to the six retainer screws.

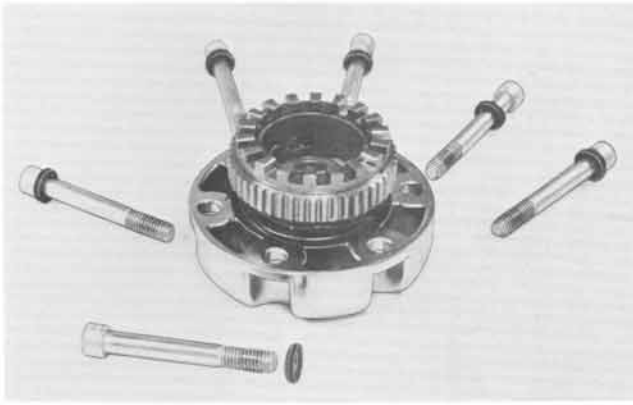

1001-17

CAUTION

(Figure 17) Dished washers are to be assembled on the screws as shown. Assemble two screws with washers into knob retainer.



1001-18

NOTE

(Figure 18) Apply a small amount of Moly XL hi-speed grease to the outer spline and teeth of the outer clutch gear. Remove any excess lubricant from the gasket surface of the retainer.



1001-19

(Figure 19) Assemble outer retainer gasket. Assemble gear hub housing by aligning the splines of the housing with those of the outer clutch gear as shown. Assemble inner (metal) gasket on hub housing.

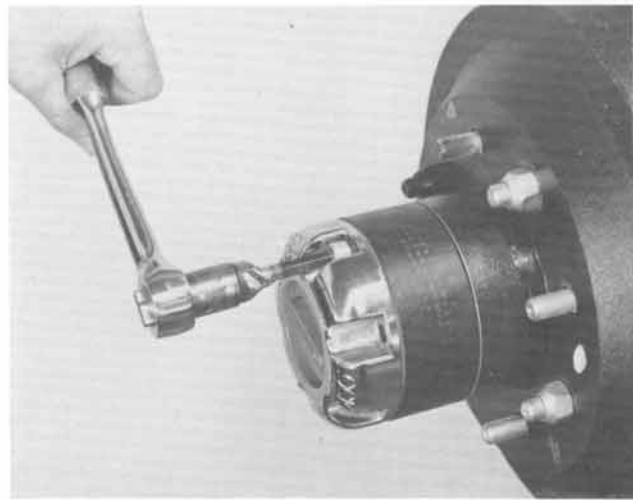

1001-20

(Figure 20) Assemble Hub/Lok sub-assembly to axle assembly using the two retainer screws as pilots to assure that the holes of the gasket are in alignment with the holes of the wheel hub. Tighten retainer screws to secure the Hub/Lok. Turn actuator knob to lock position.

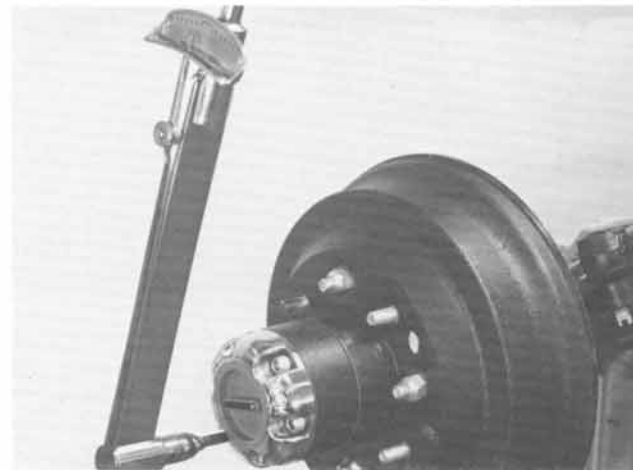

1001-21

(Figure 21) Assemble the remaining four retainer screws with washers. Tighten screws evenly. Torque to 30-35 ft. lbs. The Hub/Loks may be hard to engage and disengage, however after use, they should loosen up for easier operation. Either Hub/Lok will fit either wheel.

CAUTION

Do not drive vehicle until both Hub/Loks are either engaged or disengaged.

PARTS IDENTIFICATION

SPICER® MODEL 44 EXTERNAL TYPE HUB LOK® PARTS

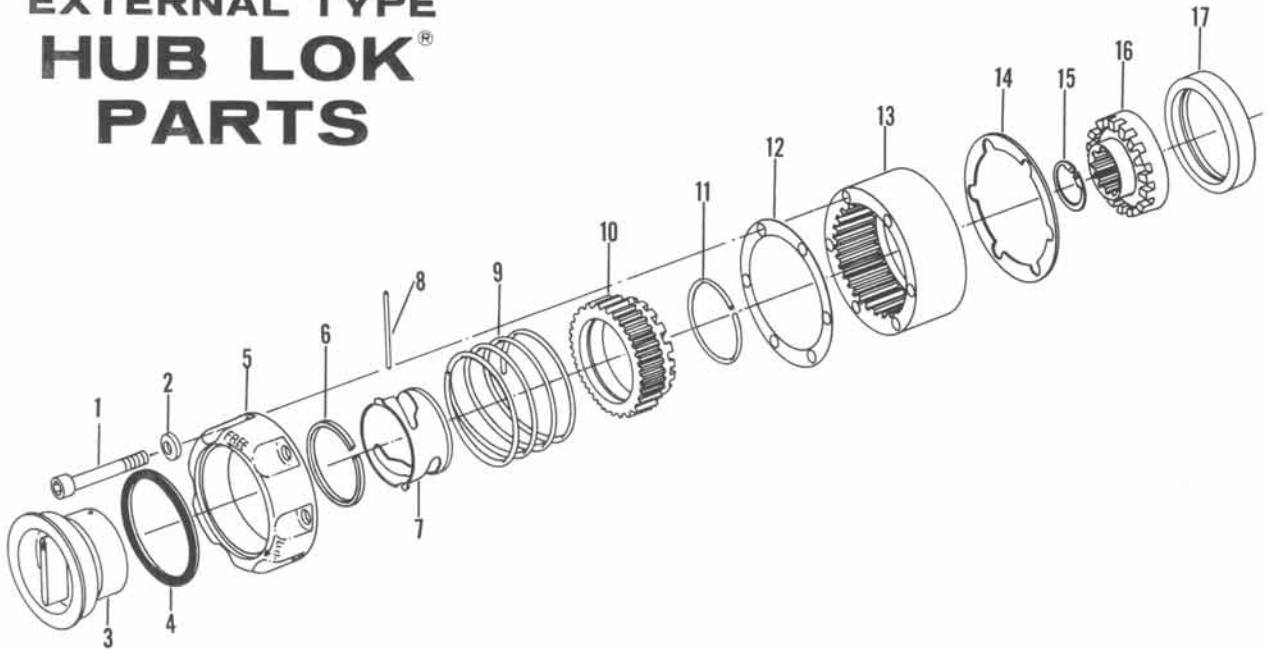

(Figure 22)

1001-22

#1	(6)	Hub/Lok retainer screws.	#10	(1)	Outer clutch gear.
#2	(6)	Dished washer.	#11	(1)	Clutch gear snap ring.
#3	(1)	Actuating knob.	#12	(1)	Outer retainer gasket.
#4	(1)	Actuating knob "O" ring.	#13	(1)	Gear hub housing.
#5	(1)	Actuating knob retainer.	#14	(1)	Inner (metal) gasket.
#6	(1)	Actuating knob retainer snap ring.	#15	(1)	Axle shaft snap ring.
#7	(1)	Actuating cam.	#16	(1)	Inner clutch gear.
#8	(1)	Actuating cam pin.	#17	(1)	Bushing.
#9	(1)	Pressure spring.			

SERVICE INSTRUCTIONS

In the event it becomes necessary to disassemble the Hub/Lok for either inspection or cleaning purposes, it is recommended that the following parts be replaced. #1 (6) retainer screws; #2 (6) dished washers; #12 (1) outer retainer gasket, and #14 (1) inner retainer (metal) gasket.

If wear or damage is evident on either part #10, outer clutch gear, or part #16, inner clutch gear, both are to be replaced as a set.

CAUTION

Threaded screw holes in the wheel hub should be cleaned before assembling new retainer screws. These holes can be cleaned by directing compressed air into the threaded holes.

For further information write to:

Axle Division
Dana Corporation
P.O. Box 1209
Ft. Wayne, Indiana 46801

Attention: Technical Service Department